

**30V P-Channel Enhancement Mode MOSFET**
**■ Features**

- $V_{DS} (V) = -30V$
- $I_D = -2.6 A (V_{GS} = -10V)$
- $R_{DS(ON)} < 130m\Omega (V_{GS} = -10V)$
- $R_{DS(ON)} < 200m\Omega (V_{GS} = -4.5V)$

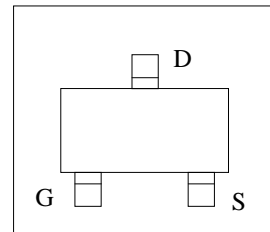
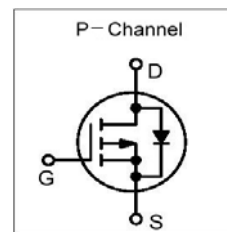
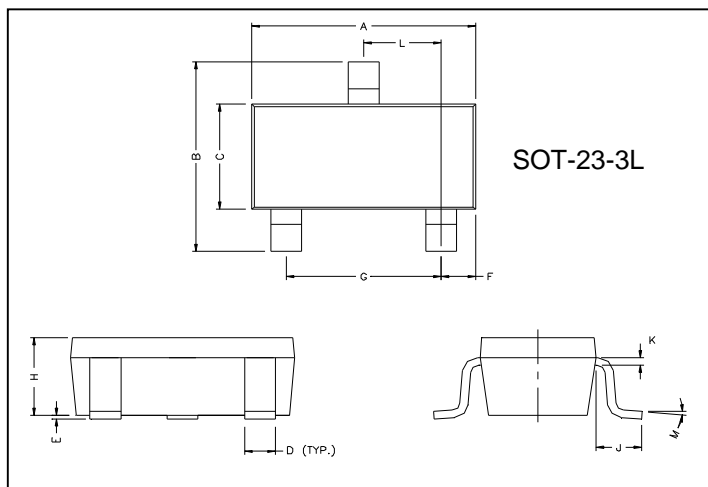

REF.	Millimeter		REF.	Millimete	
	Min.	Max.		Min.	Max.
A	2.70	3.10	G	1.90	REF.
B	2.65	2.95	H	1.00	1.30
C	1.50	1.70	K	0.10	0.20
D	0.35	0.50	J	0.40	-
E	0	0.10	L	0.85	1.15
F	0.45	0.55	M	0°	10°

**■ Absolute Maximum Ratings  $T_a = 25^\circ C$** 

Parameter	Symbol	Rating	Unit
Drain-Source Voltage	$V_{DS}$	-30	V
Gate-Source Voltage	$V_{GS}$	$\pm 20$	V
Continuous Drain Current	$I_D$	$T_A=25^\circ C$	-2.6
		$T_A=70^\circ C$	-2.2
Pulsed Drain Current	$I_{DM}$	-20	A
Power Dissipation	$P_D$	$T_A=25^\circ C$	1.4
		$T_A=70^\circ C$	1
Thermal Resistance. Junction-to-Ambient	$R_{thJA}$	100	$^\circ C/W$
Thermal Resistance. Junction-to-Case	$R_{thJC}$	63	$^\circ C/W$
Junction and Storage Temperature Range	$T_J, T_{STG}$	-55 to 150	$^\circ C$



## 30V P-Channel Enhancement Mode MOSFET

## ■ Electrical Characteristics Ta = 25°C

Parameter	Symbol	Testconditions	Min	Typ	Max	Unit	
Drain-Source Breakdown Voltage	V <sub>DSS</sub>	I <sub>D</sub> =250 μ A, V <sub>GS</sub> =0V	-30			V	
Zero Gate Voltage Drain Current	I <sub>DSS</sub>	V <sub>DS</sub> =-24V, V <sub>GS</sub> =0V			-1	μ A	
		V <sub>DS</sub> =-24V, V <sub>GS</sub> =0V, T <sub>J</sub> =55°C			-5		
Gate-Body leakage current	I <sub>GSS</sub>	V <sub>DS</sub> =0V, V <sub>GS</sub> =±20V			±100	nA	
Gate Threshold Voltage	V <sub>GS(th)</sub>	V <sub>DS</sub> =V <sub>GS</sub> I <sub>D</sub> =-250 μ A	-1	-1.9	-3	V	
Static Drain-Source On-Resistance	r <sub>DS(ON)</sub>	V <sub>GS</sub> =-10V, I <sub>D</sub> =-2.6A		97	130	mΩ	
		V <sub>GS</sub> =-10V, I <sub>D</sub> =-2.6A T <sub>J</sub> =125°C		135	150		
		V <sub>GS</sub> =-4.5V, I <sub>D</sub> =-2A		166	200	mΩ	
On state drain current	I <sub>D(ON)</sub>	V <sub>GS</sub> =-4.5V, V <sub>DS</sub> =-5V	-5			A	
Forward Transconductance	g <sub>fs</sub>	V <sub>DS</sub> =-5V, I <sub>D</sub> =-5A	3	3.8		S	
Input Capacitance	C <sub>iss</sub>	V <sub>GS</sub> =0V, V <sub>DS</sub> =-15V, f=1MHz		302	370	pF	
Output Capacitance	C <sub>oss</sub>			50.3		pF	
Reverse Transfer Capacitance	C <sub>rss</sub>			37.8		pF	
Gate resistance	R <sub>g</sub>	V <sub>GS</sub> =0V, V <sub>DS</sub> =0V, f=1MHz		12	18	Ω	
Total Gate Charge (10V)	Q <sub>g</sub>	V <sub>GS</sub> =-4.5V, V <sub>DS</sub> =-15V, I <sub>D</sub> =-2.6A		6.8	9	nC	
Total Gate Charge (4.5V)				2.4		nC	
Gate Source Charge			Q <sub>gs</sub>		1.6		nC
Gate Drain Charge			Q <sub>gd</sub>		0.95		nC
Turn-On DelayTime	t <sub>D(on)</sub>	V <sub>GS</sub> =-10V, V <sub>DS</sub> =-15V, R <sub>L</sub> =5.8 Ω, R <sub>GEN</sub> =3 Ω		7.5		ns	
Turn-On Rise Time	t <sub>r</sub>			3.2		ns	
Turn-Off DelayTime	t <sub>D(off)</sub>			17		ns	
Turn-Off Fall Time	t <sub>f</sub>			6.8		ns	
Body Diode Reverse Recovery Time	t <sub>rr</sub>	I <sub>F</sub> =-2.6A, di/dt=100A/μ s		16.8	22	ns	
Body Diode Reverse Recovery Charge	Q <sub>rr</sub>	I <sub>F</sub> =-2.6A, di/dt=100A/μ s		10		nC	
Maximum Body-Diode Continuous Current	I <sub>S</sub>				-2	A	
Diode Forward Voltage	V <sub>SD</sub>	I <sub>S</sub> =-1A, V <sub>GS</sub> =0V		-0.82	-1	V	

\* Repetitive rating, pulse width limited by junction temperature.



### 30V P-Channel Enhancement Mode MOSFET

#### ■ Typical Characteristics

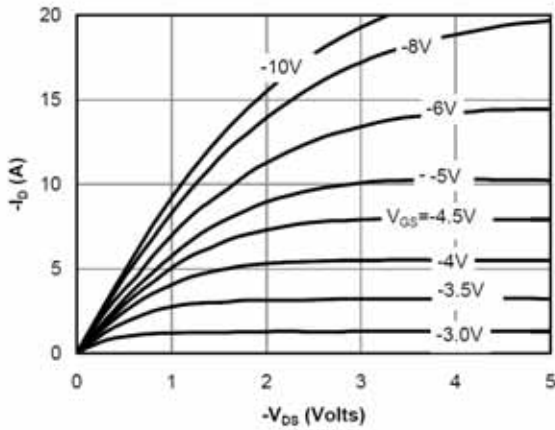

Fig 1: On-Region Characteristics

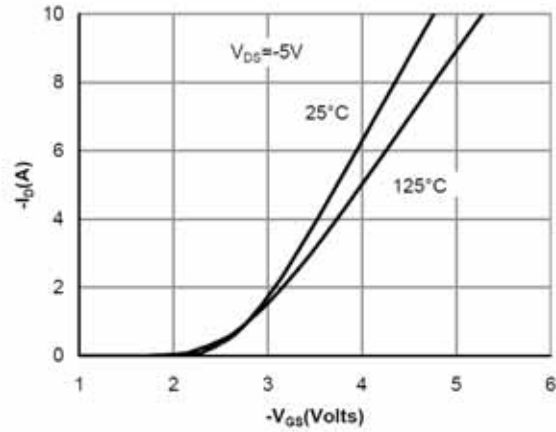

Figure 2: Transfer Characteristics

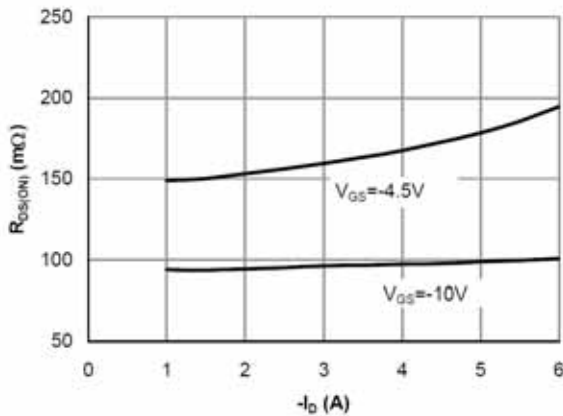

Figure 3: On-Resistance vs. Drain Current and Gate Voltage

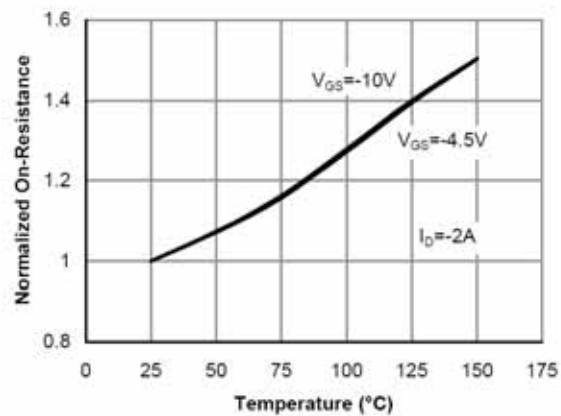

Figure 4: On-Resistance vs. Junction Temperature

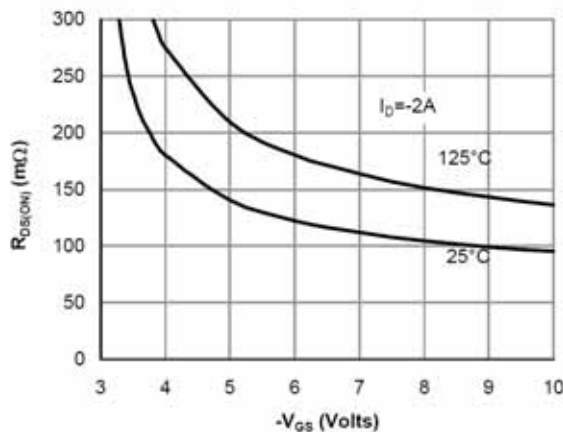

Figure 5: On-Resistance vs. Gate-Source Voltage

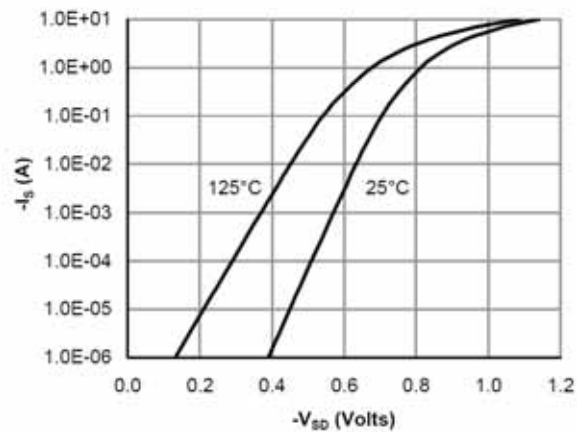

Figure 6: Body-Diode Characteristics

30V P-Channel Enhancement Mode MOSFET

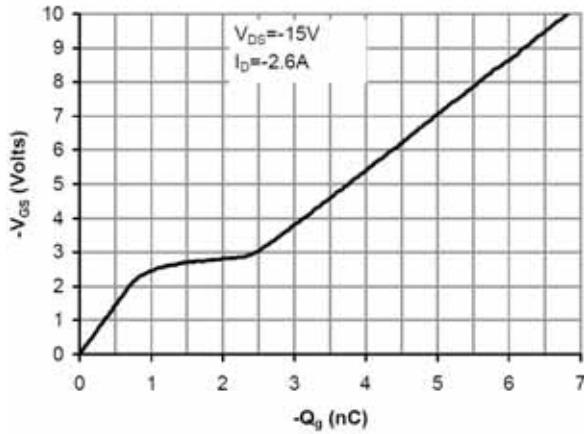

Figure 7: Gate-Charge Characteristics

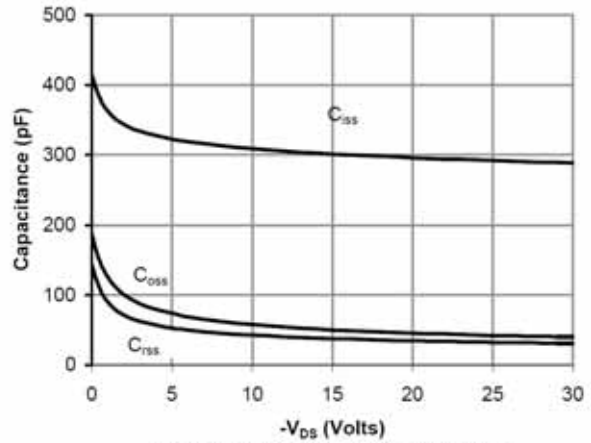

Figure 8: Capacitance Characteristics

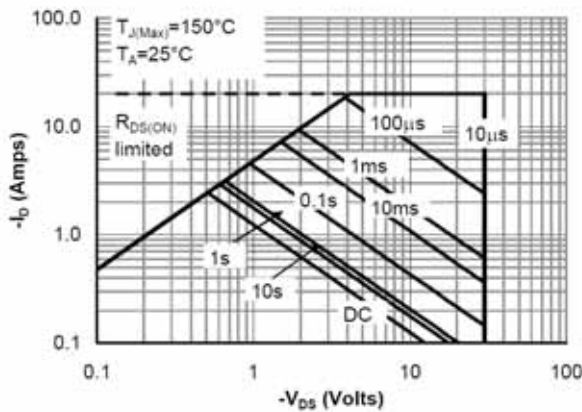

Figure 9: Maximum Forward Biased Safe Operating Area (Note E)

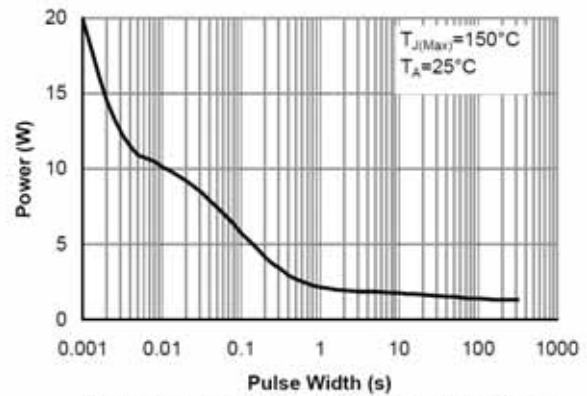

Figure 10: Single Pulse Power Rating Junction-to-Ambient (Note E)

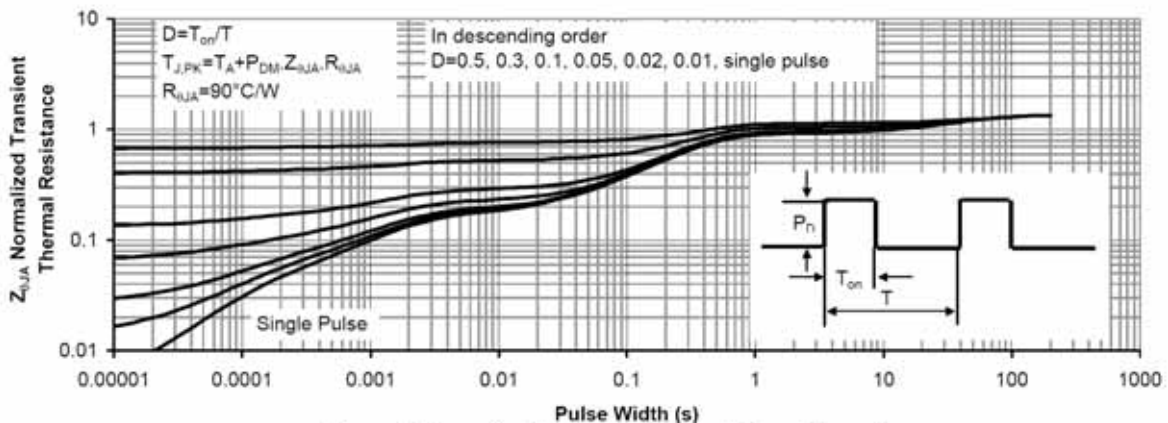

Figure 11: Normalized Maximum Transient Thermal Impedance